

SERIE ACCESORIOS PARA PRACTICABLES EUROPEAS

Catálogo de accesorios disponibles en el grupo Ayuso, que son comunes para las diferentes series abatibles con cámara europea.

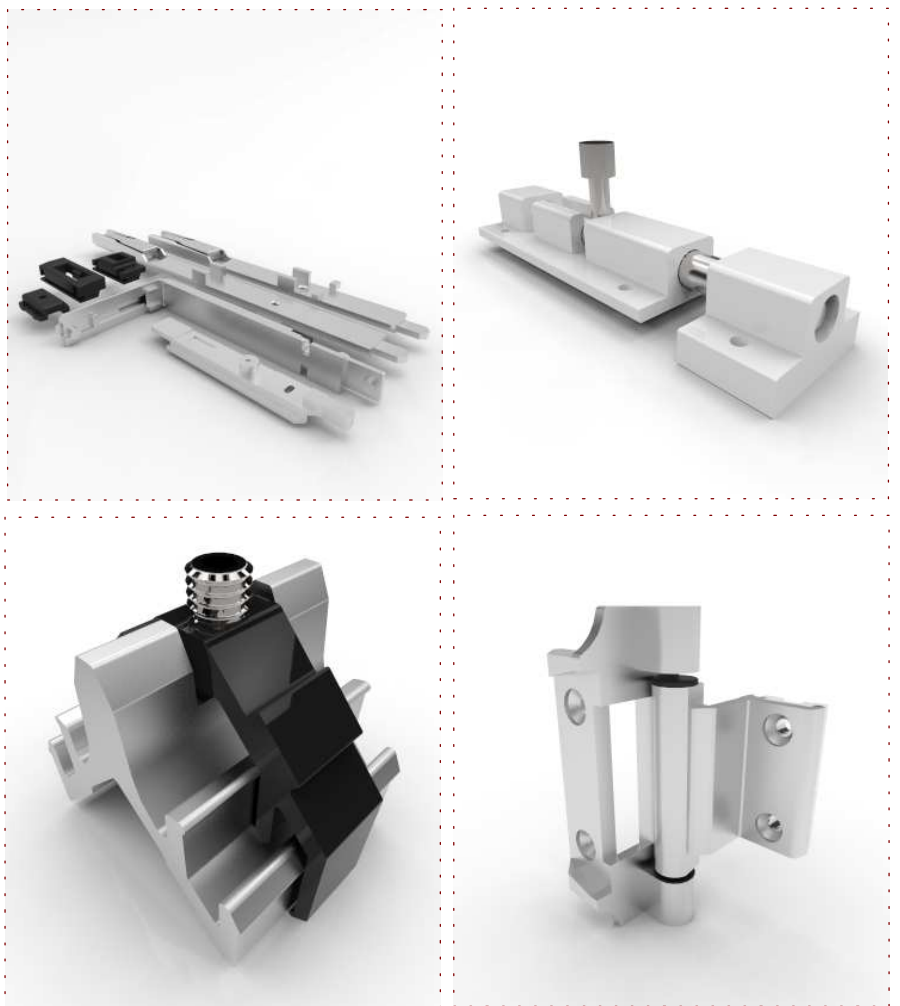

Kits para ventanas

0214- KIT OSCILO EURO DE 2 HOJAS (Galipius 2)		
Componente	Descripción	Cantidad
0202	CONJUNTO BISAGRAS OSCILO	1,00
0290	PERNIO IZ. 90 MM. MONTADO EURO	2,00
0641	CREMONA OSCILO S/EUROPA	1,00
0613	TAPA SALIDA DE AGUAS	2,00
0200	ENGANCHE CREMONA	1,00
0201	KIT BASE 2 HOJAS	1,00
0353	TOR. INOX. 5X38 INVERSORA (200 UD.)	0,02
0617	TUBO PEGAMENTO	1,00
0665	ESCUADRA ALINEACION INGLETE	8,00



Ref. 0214

0215- KIT OSCILO EURO DE 1 HOJA (Galipius 2)		
Componente	Descripción	Cantidad
0202	CONJUNTO BISAGRAS OSCILO	1,00
0641	CREMONA OSCILO S/EUROPA	1,00
0613	TAPA SALIDA DE AGUAS	2,00
0200	ENGANCHE CREMONA	1,00
0208	KIT BASE 1 HOJA	1,00
0617	TUBO PEGAMENTO	1,00
0665	ESCUADRA ALINEACION INGLETE	4,00



Ref. 0215

0270- KIT PRACTICABLE EURO DE 1 HOJA		
Componente	Descripción	Cantidad
0269	PERNIO DESMONTADO EURO 90 MM.DH-IZ.	2,00
0600	CREMONA S/EUROPA 2 PATAS	1,00
0613	TAPA SALIDA DE AGUAS	2,00
0630	CONJUNTO CIERRES CREMONA S/EURO	1,00
0617	TUBO PEGAMENTO	1,00
0665	ESCUADRA ALINEACION INGLETE	4,00



Ref. 0270 (1 Ventana)
 Ref. 0271 (15 Ventanas)

Nota: El Kit 0271 contiene las mismas referencias pero para 15 ventanas.

0272- KIT PRACTICABLE EURO DE 2 HOJAS		
Componente	Descripción	Cantidad
0289	PERNIO DH. 90 MM. MONTADO EURO	2,00
0290	PERNIO IZ. 90 MM. MONTADO EURO	2,00
0600	CREMONA S/EUROPA 2 PATAS	1,00
0613	TAPA SALIDA DE AGUAS	2,00
0630	CONJUNTO CIERRES CREMONA S/EURO	1,00
0353	TOR. INOX. 5X38 INVERSORA (200 UD.)	0,02
0617	TUBO PEGAMENTO	1,00
0665	ESCUADRA ALINEACION INGLETE	8,00



Ref. 0272 (1 Ventana)
 Ref. 0273 (15 Ventanas)

Nota: El Kit 0273 contiene las mismas referencias pero para 15 ventanas.

Kits para ventanas

0194-A - KIT OSCILO COMPLETO 1H - COMPÁS CORTO (Galicube 110)		
Componente	Descripción	Cantidad
0194-I	BISAGRAS HOJA ACTIVA	1,00
0194-R1	COMPÁS CORTO	1,00
0194-K1	KIT 1 HOJA	1,00
Cremona	Cremona Fapim	1,00
Eganche	Eganche para Cremona Fapim	1,00



0194-B - KIT OSCILO COMPLETO 1H - COMPÁS MEDIO (Galicube 110)		
Componente	Descripción	Cantidad
0194-I	BISAGRAS HOJA ACTIVA	1,00
0194-R2	COMPÁS MEDIO	1,00
0194-K1	KIT 1 HOJA	1,00
Cremona	Cremona Fapim	1,00
Eganche	Eganche para Cremona Fapim	1,00



0194-E - KIT OSCILO COMPLETO 2H - COMPÁS CORTO (Galicube 110)		
Componente	Descripción	Cantidad
0194-I	BISAGRAS HOJA ACTIVA	1,00
0194-J	BISAGRAS HOJA PASIVA	1,00
0194-R1	COMPÁS CORTO	1,00
0194-K2	KIT 2 HOJA	1,00
Cremona	Cremona Fapim	1,00
Eganche	Eganche para Cremona Fapim	1,00



0194-F - KIT OSCILO COMPLETO 2H - COMPÁS MEDIO (Galicube 110)		
Componente	Descripción	Cantidad
0194-I	BISAGRAS HOJA ACTIVA	1,00
0194-J	BISAGRAS HOJA PASIVA	1,00
0194-R2	COMPÁS MEDIO	1,00
0194-K2	KIT 2 HOJA	1,00
Cremona	Cremona Fapim	1,00
Eganche	Eganche para Cremona Fapim	1,00



Glosario de Accesorios



Ref.- 0005
 Spray Pintura Colores.



Ref.- 0006
 Cremona Apertura Exterior

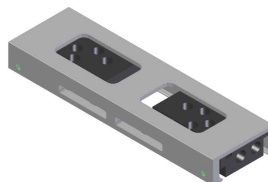

Ref.- 0007
 Enganche Cremona 0006



Ref.- 0008
 Perno Transmision Cremona 0006



Ref.- 0055
 Cierre Presion de Rodillo Derecha

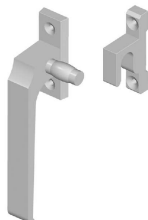

Ref.- 0056
 Cierre Presion de Rodillo Izquierda

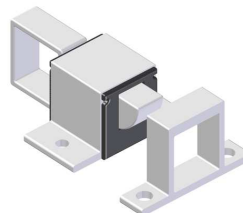

Ref.- 0057
 Cierre Golpete



Ref.- 0060
 Compas Basculante

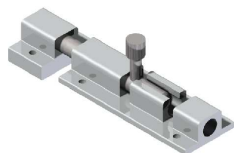

Ref.- 0073
 Pasador 100



Ref.- 0077
 Pasador 300



Ref.- 0085 (*)
 Juego Tirador Style 350 mm

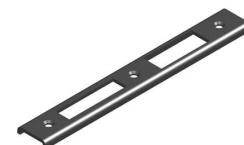

Ref.- 0091
 Cerradero de Aluminio

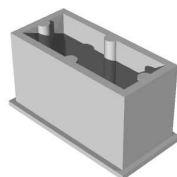

Ref.- 0099
 Tapon PVC Tubo 30x15 y Alfeizar

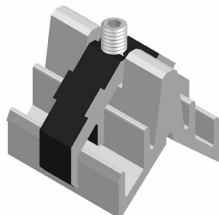

Ref.- 0126
 Escuadra Tensor 30x15

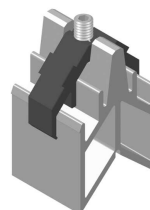

Ref.- 0127
 Escuadra Tensor 30x31,6

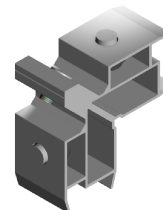

Ref.- 0128
 Escuadra Teton 30x31,8

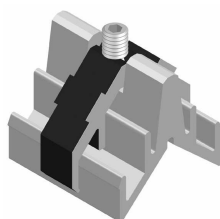

Ref.- 0132
 Escuadra Tensor 37x15

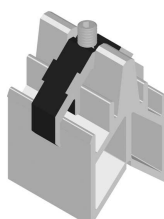

Ref.- 0144
 Escuadra Tensor 37x31,6

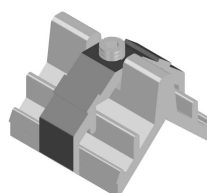

Ref.- 0147
 Escuadra Tensor 37x11

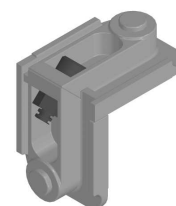

Ref.- 0149
 Escuadra Teton 37x15

Glosario de Accesorios

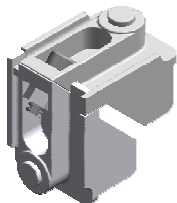

Ref.- 0153
 Escuadra Teton 37x31



Ref.- 0194-A
 Kit Oscilo 1H
 Compás Corto



Ref.- 0194-B
 Kit Oscilo 1H
 Compás Medio



Ref.- 0194-E
 Kit Oscilo 2H
 Compás Corto



Ref.- 0194-F
 Kit Oscilo 2H
 Compás Medio

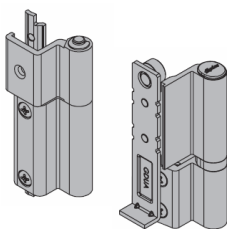

Ref.- 0194-I
 Bisagras Hoja Activa

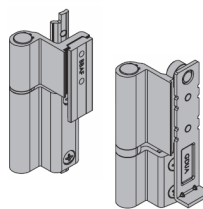

Ref.- 0194-J
 Bisagras Hoja Pasiva



Ref.- 0194-K1
 Kit Base 1 H

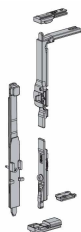

Ref.- 0194-K2
 Kit Base 2 Hojas

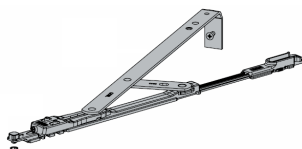

Ref.- 0194-R1
 Compás Corto
 (402 - 750 mm)

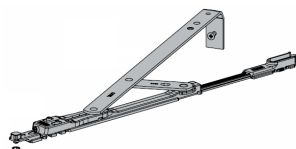

Ref.- 0194-R2
 Compás Medio
 (562 - 1200 mm)

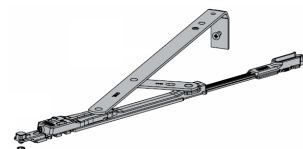

Ref.- 0194-R3
 Compás Larfo
 (816 - 1700 mm)



Ref.- 0195
 Microventilación oscilo

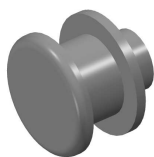

Ref.- 0197
 Pernio Empalme con
 Cremona Oscilo

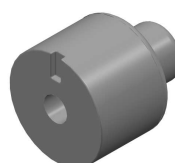

Ref.- 0198
 Bulon Punto Cierre Oscilo

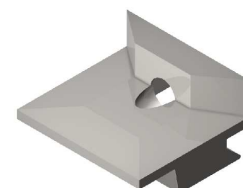

Ref.- 0199
 Cerradero para Bulon 0198

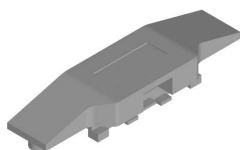

Ref.- 0200
 Enganche Cremona

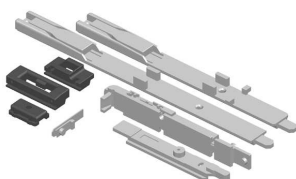

Ref.- 0201
 Kit Base 2 Hojas

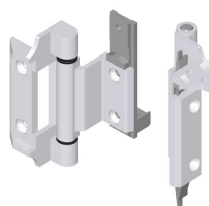

Ref.- 0202
 Conjunto Bisagras Oscilo

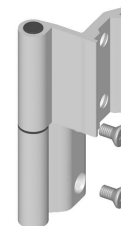

Ref.- 0203
 Und. Pernio Hoja Pasiva

Glosario de Accesorios



Ref.- 0204
 Compas Hojas
 de 361 a 600



Ref.- 0205
 Compas Hojas
 de 400 a 650



Ref.- 0206
 Compas Hojas
 de 570 a 1200



Ref.- 0207
 Angulo de Reenvío

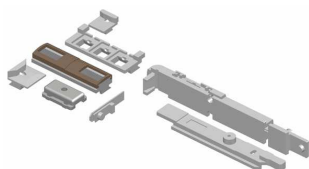

Ref.- 0208
 Kit Base 1 Hoja



Ref.- 0213
 Und. Bisagra Hoja Pasiva



Ref.- 0214
 Kit Oscilo Europeo
 2 Hojas



Ref.- 0215
 Kit Oscilo Europeo
 1 Hoja



Ref.- 0219-E
 Escuadra de Alineación

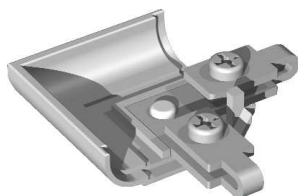

Ref.- 0233
 Nudo Solape 6085



Ref.- 0241
 Cremona Apertura
 Exterior

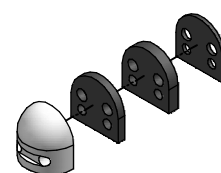

Ref.- 0242
 Cerradero

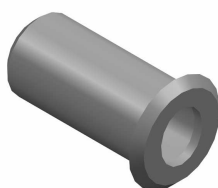

Ref.- 0243
 Cerradero Suelo

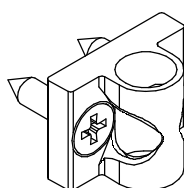

Ref.- 0244
 Soporte Varilla



Ref.- 0245
 Embellecedor +
 Varilla 1800 mm



Ref.- 0246
 Embellecedor +
 Varilla 1000 mm



Ref.- 0247
 Embellecedor +
 Varilla 1400 mm

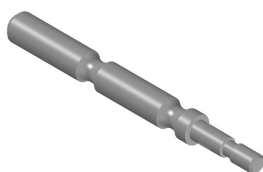

Ref.- 0258
 Terminal Recto Apertura
 Exterior

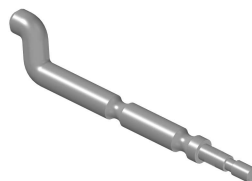

Ref.- 0259
 Terminal Curvo Apertura
 Exterior

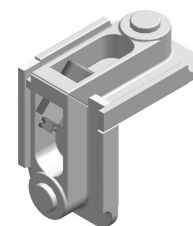

Ref.- 0263
 Escuadra Teton 30x15

Glosario de Accesorios



Ref.- 0265
 Escuadra Teton 17x15

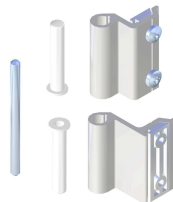

Ref.- 0269
 Pernio Desmontado Euro 90
 MM DH-IZ.



Ref.- 0270
 Kit Practicable Euro 1H



Ref.- 0270
 Kit Practicable Euro 2H



Ref.- 0270
 Kit Practicable Euro 1H
 15 ventanas



Ref.- 0270
 Kit Practicable Euro 2H
 15 ventanas

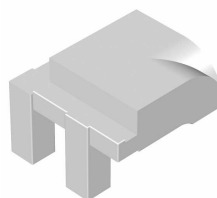

Ref.- 0281
 Embellecedor Junquillo



Ref.- 0283
 Cerrojo Hoja Pasiva



Ref.- 0289
 Pernio DH.90 Montado
 (Euro)

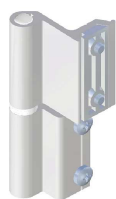

Ref.- 0290
 Pernio IZ.90 mm Montado
 (Euro)

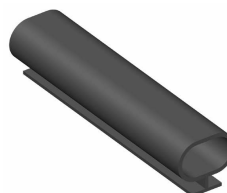

Ref.- 0453
 Goma Estanq. Hoja
 (100 m)



Ref.- 0454
 Goma Estanq. Hoja
 (100 m)

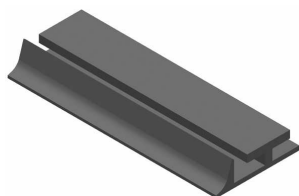

Ref.- 0464
 Goma Cerco Exterior
 (100 m)



Ref.- 0466
 Goma Cuña Pequeña
 (100 m)



Ref.- 0507
 Conjunto Manillas Esc.
 Recuperable



Ref.- 0509
 Cerradura PIC+PA 25 MM



Ref.- 0600
 Cremona 2 Patas (Euro)



Ref.- 0604
 Bisagra de Puerta (Euro)



Ref.- 0607
 Taco Ventana



Ref.- 0608
 Taco Puerta

Glosario de Accesorios



Ref.- 0610
 Taco Puerta
 (PT50 y PT60)

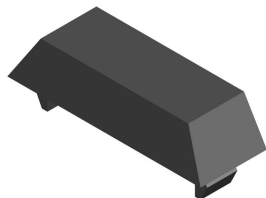

Ref.- 0613
 Tapa Salida de Aguas

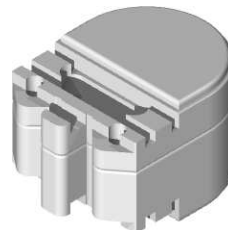

Ref.- 0616
 Conjunto Pernios
 Pivontate (Euro)



Ref.- 0617
 Tubo Pegamento

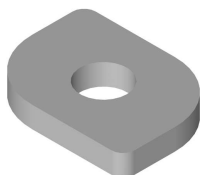

Ref.- 0619 (*)
 Tuerca Excentrica



Ref.- 0624
 Ruleta para Goma

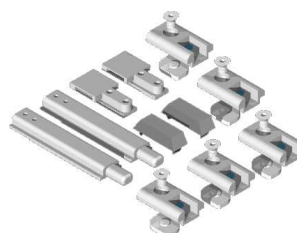

Ref.- 0630
 Conjunto Cierres
 Cremona S/Euro

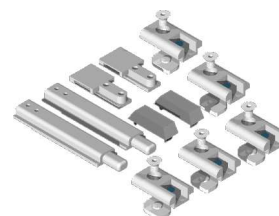

Ref.- 0630-M1
 Conjunto Cierres
 Cremona 1H

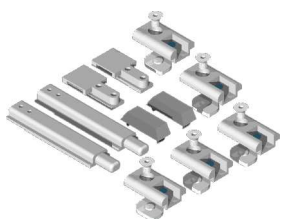

Ref.- 0630-M2
 Conjunto Cierres
 Cremona 2H

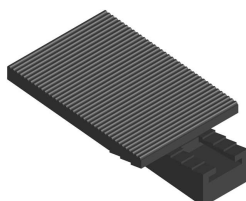

Ref.- 0639
 Calzo Cristal (Termic)



Ref.- 0641
 Cremona Oscilo (Euro)

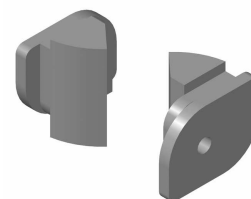

Ref.- 0650
 Cierre Hoja Pasiva



Ref.- 0662
 Cerrojo Hoja Pasiva



Ref.- 0665
 Escuadra Alineación
 Inglete

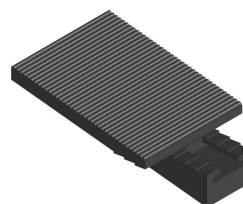

Ref.- 0678
 Calzo Cristal (Practic)



Ref.- 0679
 Conjunto Cerradura



Ref.- 0683
 Kit Pareja Puntos Cierre
 Cerradura

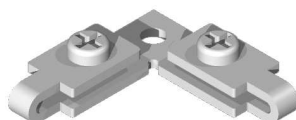

Ref.- 0698
 Escuadra Solape

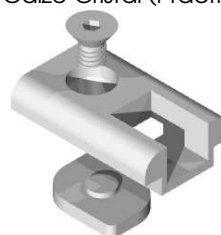

Ref.- 0706
 Enganche Cremona PVC
 Completo

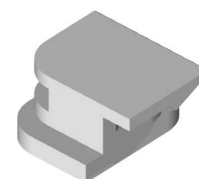

Ref.- 0708
 Grapa Junquillo Redondo
 (100 unds.)

Glosario de Accesorios

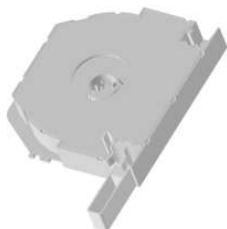

Ref.- 0758 (*)
Pareja Testeros Cajon
Persiana

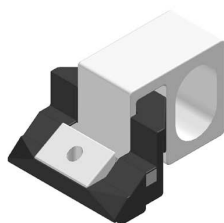

Ref.- 0795
Cierre Golpete



Ref.- 0796
Compas Basculante 220 mm
Ref.- 0797
Compas Basculante 150 mm

Ref.- 1012
Útil Practicables Europeas

Gomas - Acristalamiento

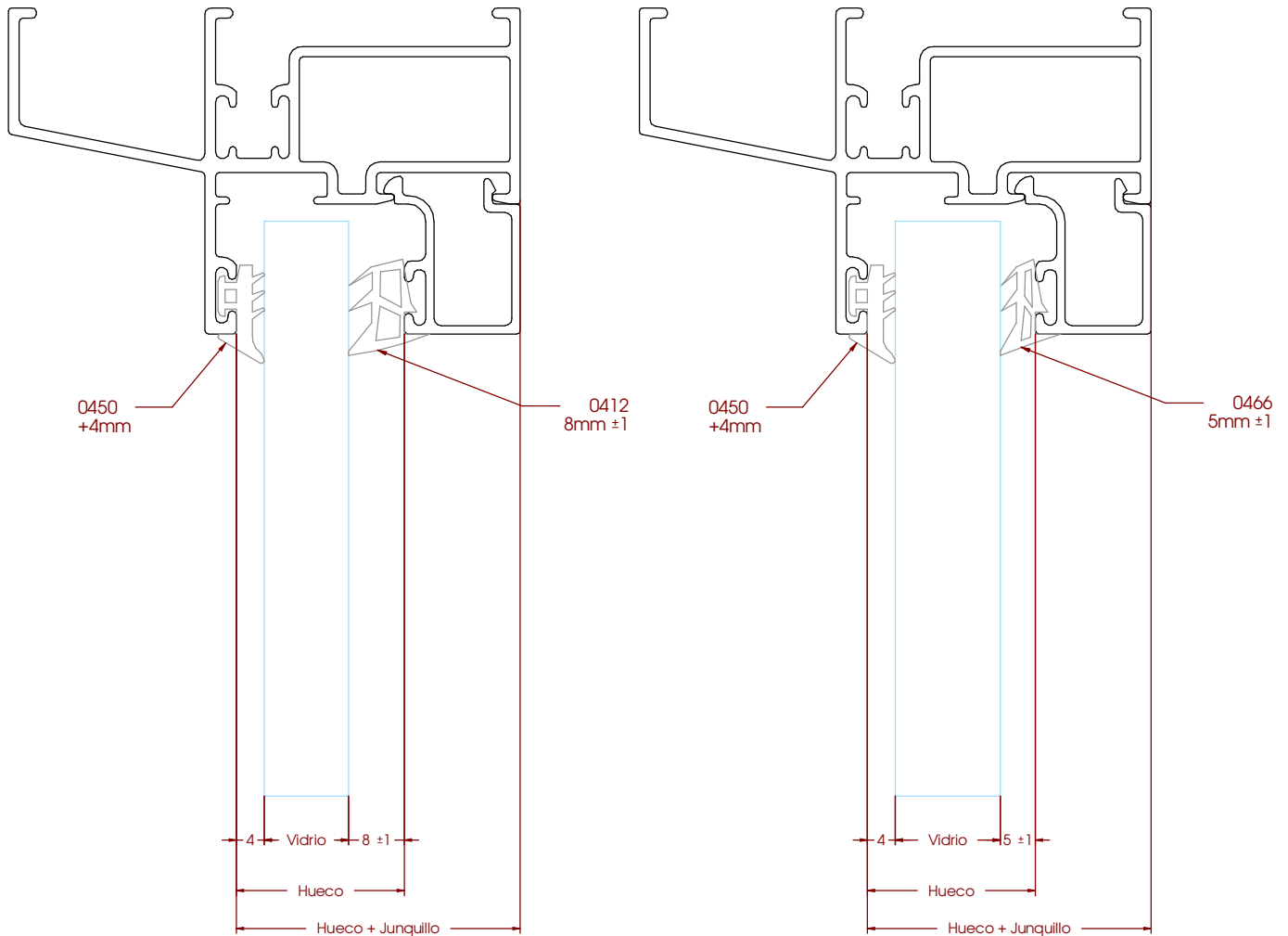

Ejemplo:

Para un hueco de 30mm y una composición de vidrio de 20mm, tendremos que usar la combinación de gomas 0450+0466

COMBINACIÓN DE GOMAS NECESARIAS PARA CADA HUECO - VIDRIO

	Hueco - Vidrio					
	8mm	9mm	10mm	11mm	12mm	13mm
Goma Interior	0466	0466	0466	0412	0412	0412
Goma Exterior	0450	0450	0450	0450	0450	0450

Nota: Medidas para acristalamiento con goma interior y goma exterior.
 Consulta el valor de "Hueco" en la tabla de acristalamientos de cada serie.

Mecanizado para las Pletinas ref. 1608

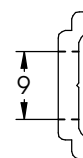
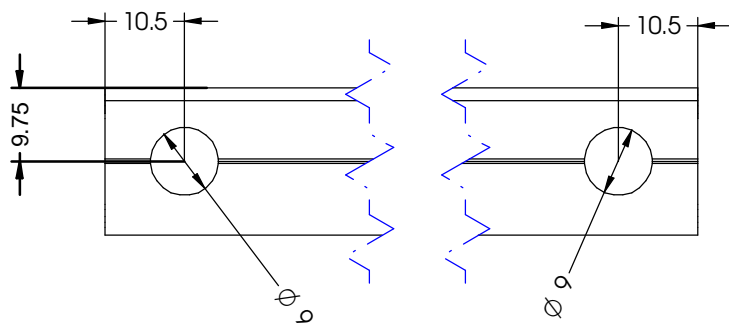

Pletina Ref. 1608

Nota: Mecanizado realizado por el útil Ref.1012 - Útil series europeas

Descuentos para pletinas de la cremona ref.0600

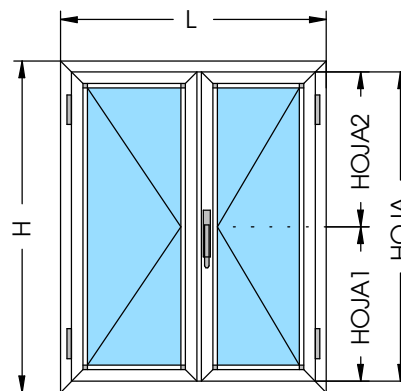
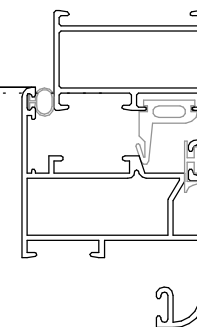
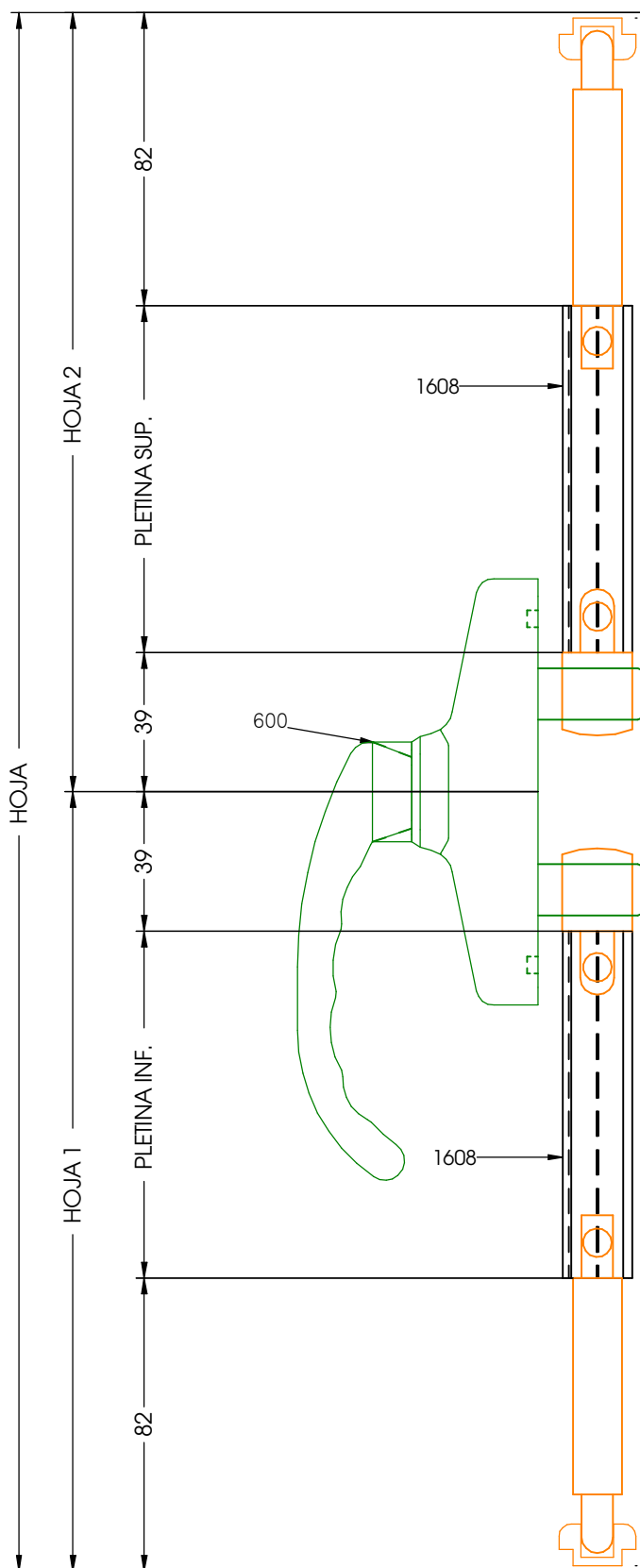

Pletina Inferior = HOJA1 - 121
Pletina Superior = HOJA2 - 121

CENTRADO EN HOJA
(HOJA - 242) / 2

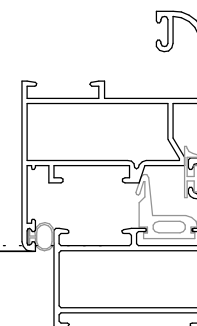

Nota: Valido tanto para perfiles de ventana como de puerta

Accesorio Oscilobatiente 1H - Galiplus2

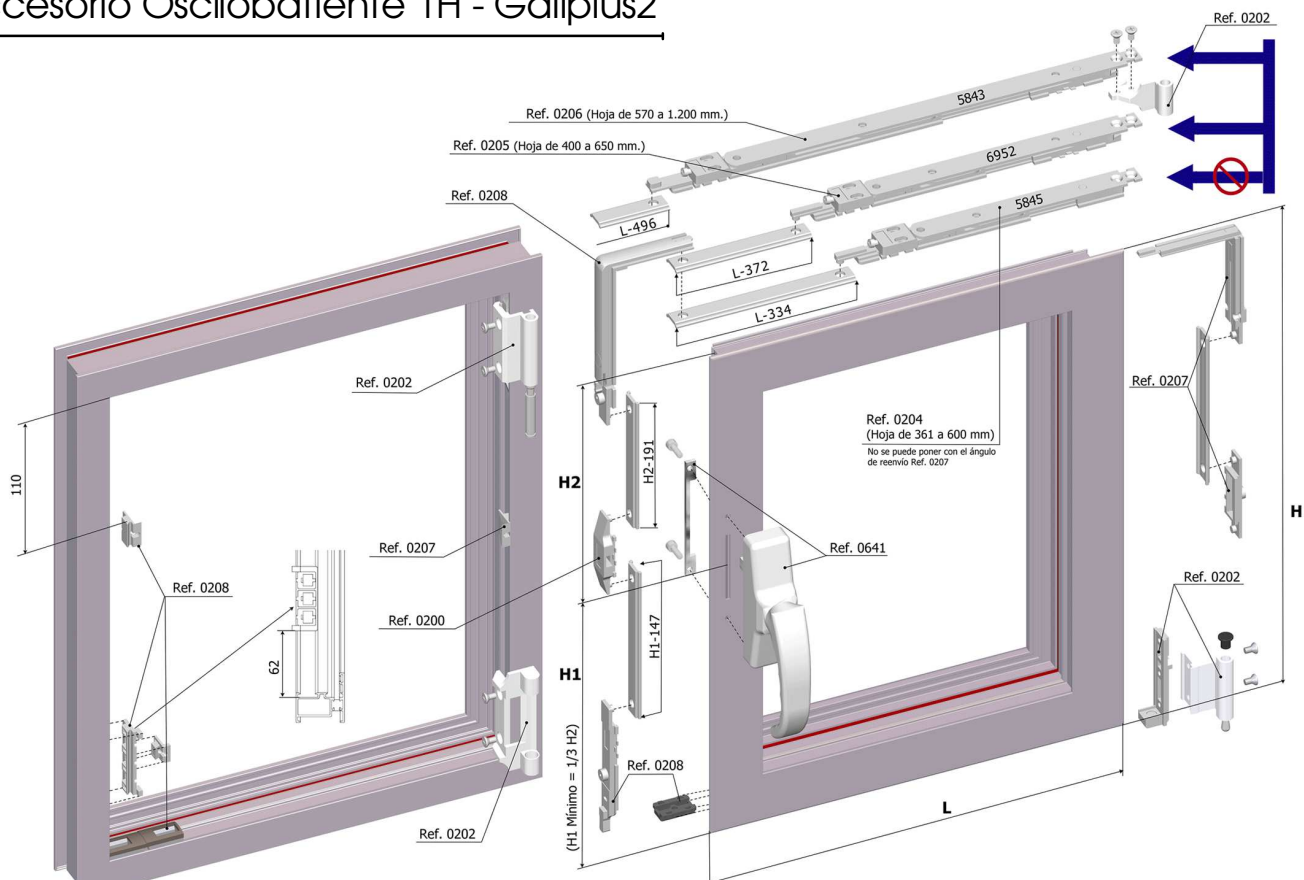

REF.	PIEZAS	DESCRIPCIÓN
0200		- Enganche Cremona.
0208		- Kit Base 1 Hoja: 1.- Escuadra de reenvío 2.- Terminal de cremona 3.- Enganche cierre hoja 4.- Soporte y enganche hoja 5.- Cierre vertical cremona 6.- Resbalón
0202		- Conjunto Bisagras Oscilo.
0204		- Compás (Hoja de 361 a 600 mm). La referencia 0207 no se puede montar con este compás.
0205		- Compás (Hoja de 400 a 650 mm).
0206		- Compás (Hoja de 570 a 1200 mm).
0641		- Cremona.
0207		- Ángulo de Reenvío. (OPCIONAL) La referencia 0207 se recomienda para hojas con más de 1.200 mm. de altura.

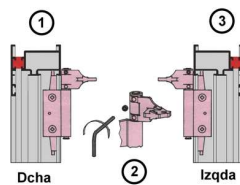

Montaje pernio superior Dcha. e Izqda.
Una vez introducido el bulón, poner el tornillo de fijación como muestra la figura 2.

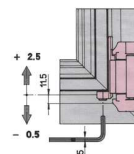

Regulación de hoja en altura.
Para regular la hoja aflojar los tornillos del pernio y regular con la llave según se muestra en el detalle. Una vez regulado volver a apretar los tornillos del pernio.

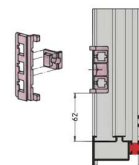

Enganche de cierre de hoja.



Regulación pernio inferior.
Con un a llave allen de 2,5 mm se regula ± 1 mm en el ancho.

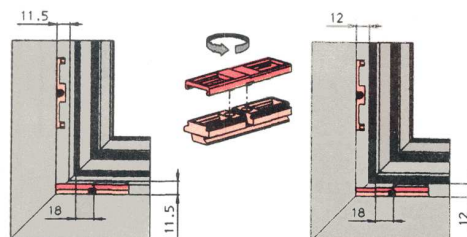

Soporte y enganche de hoja.
Cambiando la posición del soporte se varía el desplazamiento horizontal de la hoja en medio milímetro (más o menos).

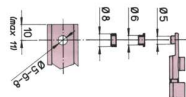

Medidas de los taladros para la pletina.
Los tacos de nylon incorporados son para diferentes medidas de taladros en las pletinas, según se muestra en el detalle.

MANTENIMIENTO
Regulación: Cada 2.000 Oscilos.
Lubricación: Cada 4 meses en las piezas mecánicas.

Accesorio Oscilobatiente 2H - Galiplus2

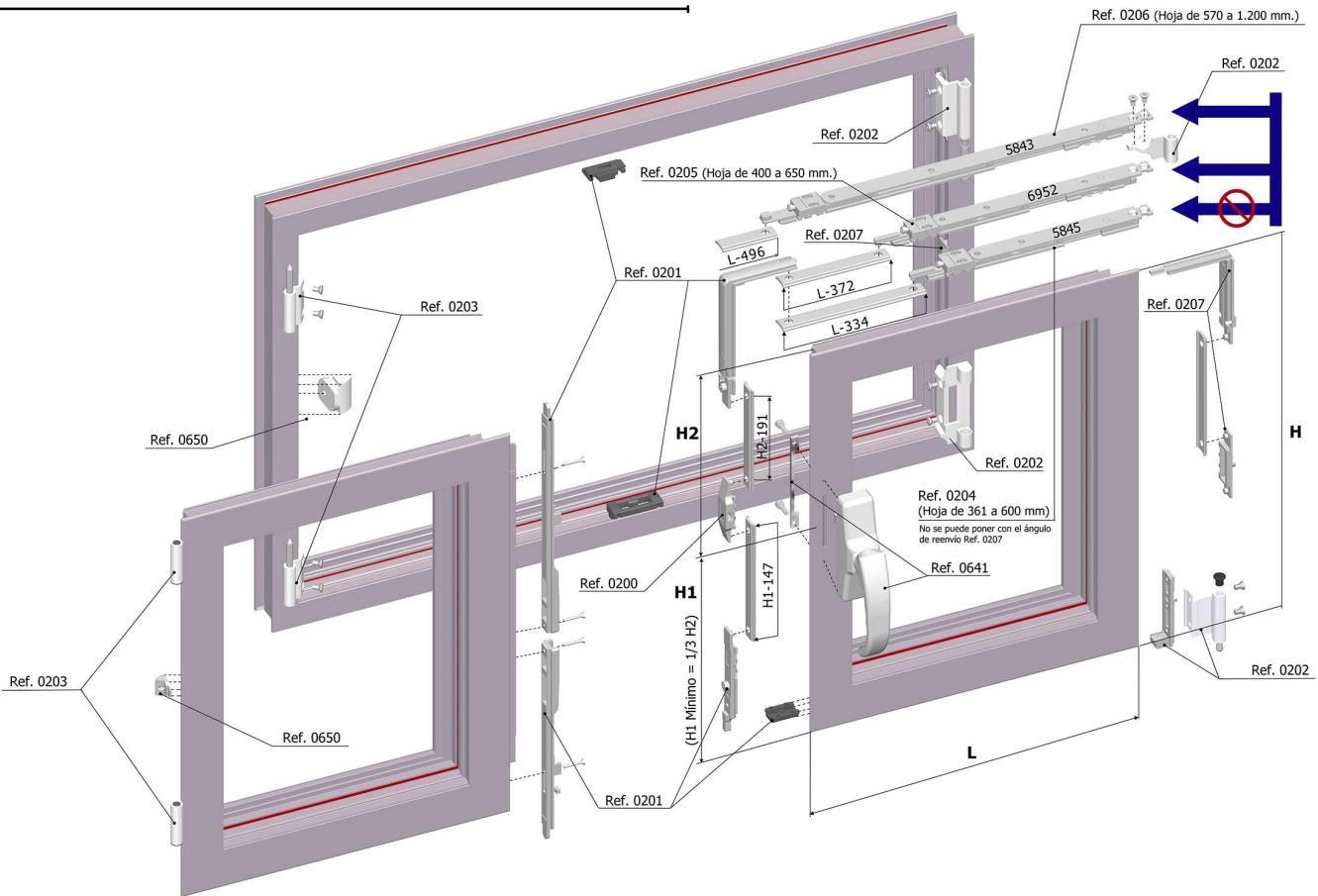

REF.	PIEZAS	DESCRIPCIÓN
0200		- Enganche Cremona.
0201		- Kit Base 2 Hojas: 1.- Cerrojo inferior 5.- Taco superior cerrojos 2.- Cerrojo superior 6.- Taco inferior cerrojos 3.- Escuadra reenvío 7.- Resbalón 4.- Terminal de cremona
0202		- Conjunto Bisagras Oscilo.
0203		- Conjunto Bisagras Hoja Pasiva.
0204		- Compás (Hoja de 361 a 600 mm). La referencia 0207 no se puede montar con este compás.
0205		- Compás (Hoja de 400 a 650 mm).
0206		- Compás (Hoja de 570 a 1200 mm).
0641		- Cremona.
0207		- Ángulo de Reenvío. (OPCIONAL) La referencia 0207 se recomienda para hojas con más de 1.200 mm. de altura.
0650		- Cierre Vertical Hoja Pasiva. (OPCIONAL) La referencia 0650 se recomienda para hojas con más de 1.200 mm. de altura.

Montaje perno superior Dcha. e Izqda.

Una vez introducido el bulón, poner el tornillo de fijación como muestra la figura 2.

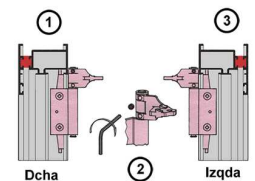

Taladros de los cerrojos.

Comenzando a medir desde el detalle A, taladrar a la medida 1 y 2.

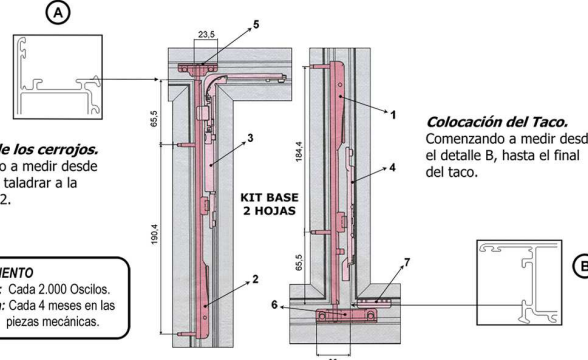

MANTENIMIENTO

Regulación: Cada 2.000 Oscilos.
Lubricación: Cada 4 meses en las piezas mecánicas.

Regulación de hoja en altura.

Para regular la hoja afojar los tornillos del pernio y regular con la llave según se muestra en el detalle. Una vez regulado volver a apretar los tornillos del pernio.

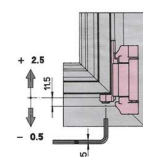

Regulación perno inferior.

Con un a llave allen de 2,5 mm se regula ±1 mm en el ancho.

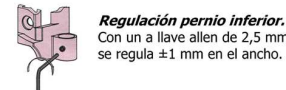

Medidas de los taladros para la pletina.

Los tacos de nylon incorporados son para diferentes medidas de taladros en las pletinas, según se muestra en el detalle.

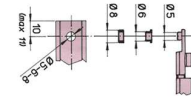

Dimensiones - Accesorio Oscilobatiente - Galipus 2

COMPÁS	MEDIDA DE HOJA			
	DIMENSIONES MÁXIMAS		DIMENSIONES MÍNIMAS	
	H max.	L max.	H min.	L min.
0204 - Compás Pequeño	1800	700	450	364
0205 - Compás Mediano	2400	750	500	402
0206 - Compás grande	2600	1400	700	526

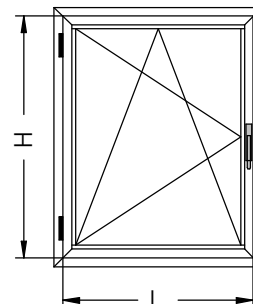

PESOS MÁXIMOS SOPORTADOS POR EL HERRAJE OSCILOBATIENTE

El peso máximo que soporta el herraje de la hoja oscilo-batiente es de 130Kg.

2600	40	40	38	33	29	25	22	20	18	17	15	14	13	13	12
2500	40	40	40	35	30	26	23	21	19	17	16	15	14	13	12
2400	40	40	40	36	31	27	24	22	20	18	17	15	14	14	13
2300	40	40	40	38	32	28	25	23	21	19	17	16	15	14	13
2200	40	40	40	39	34	30	26	24	21	20	18	17	16	15	14
2100	40	40	40	40	35	31	28	25	23	21	19	18	17	15	15
2000	40	40	40	40	37	33	29	26	24	22	20	19	17	16	15
1900	40	40	40	40	39	34	30	27	25	23	21	20	18	17	16
1800	40	40	40	40	40	36	32	29	26	24	22	21	19	18	17
1700	40	40	40	40	40	38	34	31	28	25	24	22	20	19	18
1600	40	40	40	40	40	40	36	33	30	27	25	23	22	20	19
1500	40	40	40	40	40	40	39	35	32	29	27	25	23	22	20
1400	40	40	40	40	40	40	40	37	34	31	29	27	25	23	22
1300	40	40	40	40	40	40	40	40	36	33	31	29	27	25	24
1200	40	40	40	40	40	40	40	40	39	36	33	31	29	27	25
1100	40	40	40	40	40	40	40	40	40	39	36	34	32	30	28
1000	40	40	40	40	40	40	40	40	40	40	40	37	35	33	31
900	40	40	40	40	40	40	40	40	40	40	40	40	39	36	34
800	40	40	40	40	40	40	40	40	40	40	40	40	40	40	X
700	40	40	40	40	40	40	40	40	40	40	40	40	X	X	X
600	40	40	40	40	40	40	40	40	40	40	X	X	X	X	X
500	40	40	40	40	40	40	40	40	X	X	X	X	X	X	X
450	40	40	40	40	40	X	X	X	X	X	X	X	X	X	X
	364	400	525	600	700	800	900	1000	1100	1200	1300	1400	1500	1600	1700
	ANCHO														

Notas:

Los datos obtenidos son los espesores máximos de cristal para cada medida de hoja (En el espesor de cristal no hay que incluir la cámara del vidrio).

En las casillas de sombreadas se indica el espesor máximo de cristal que se puede instalar para no sobrepasar el peso de 130 Kg.

Las casillas marcadas con "X" no se pueden realizar.

En las casillas de sombreado blanco no existe problema, ya que soporta más espesor del que se puede acristalar (se ha limitado el valor a 40mm).

Dimensiones - Accesorio Practicable 2 palas

Bisagra Ref.0203 para perfiles con Camara Europea.

Cuerpo de la bisagra de aluminio extruido anodizado ó lacado.

Eje de rotación de acero inox.

Casquillo de rotación de nylon autolubrificante.

Tornillos y placas de fijación de acero inox preensamblados.

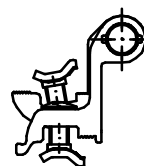

Ref. 0203

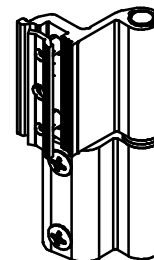

LÍMITE DE EMPLEO ACONSEJADO

Apertura Practicable (medidas por hoja):

Alto máximo recomendado: 2.400 mm

Ancho máximo Recomendado: 1.200 mm

Las medidas máximas pueden ser limitadas por el peso del vidrio. Revisar gráfico de medidas según peso y dimensiones.

Bisagras aconsejadas según peso y dimensiones

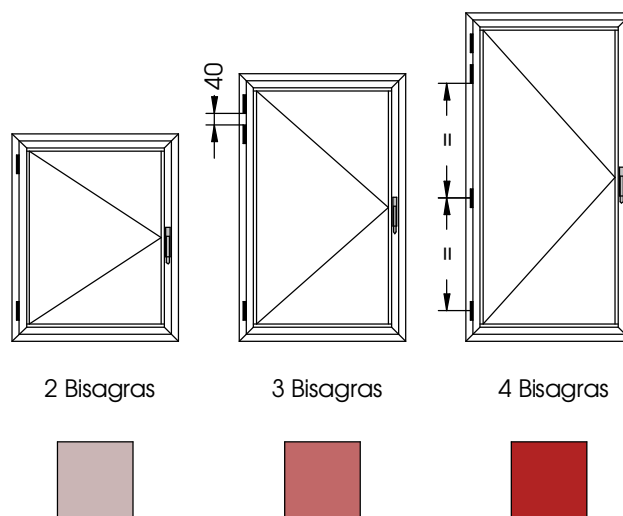
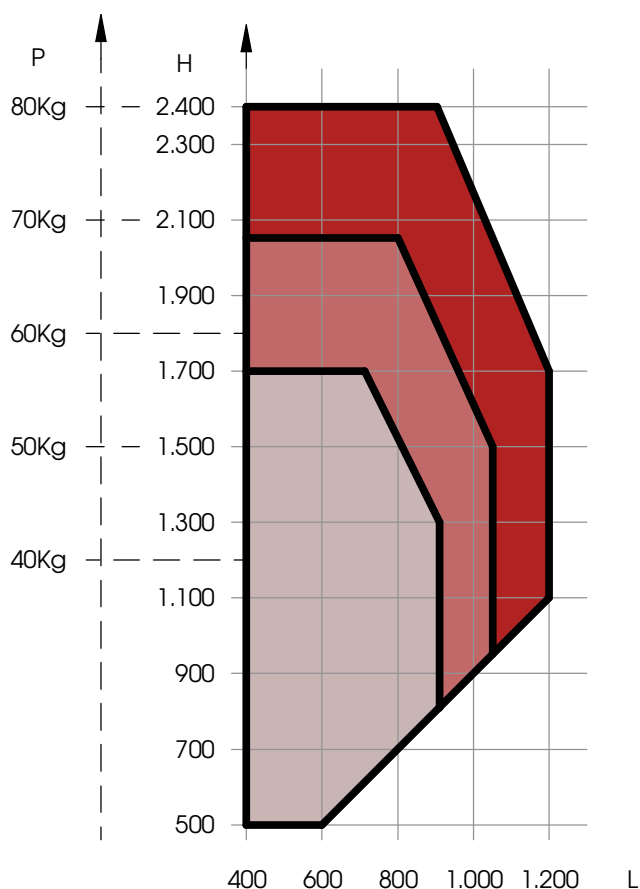

Posicionamiento de la Bisagra

Dimensiones - Accesorio Practicable de 3 palas

Bisagra Ref.0213 para perfiles con Camara Europea.

Cuerpo de la bisagra de aluminio extruido anodizado ó lacado.

Eje de rotación de acero inox.

Casquillo de rotación de nylon autolubricante.

Tornillos y placas de fijación de acero inox preensamblados.

Predisposición a la clavija de seguridad para evitar el deslizamiento vertical.

Aspecto externo igual a la bisagra oscilo-batiente.



Ref. 0213

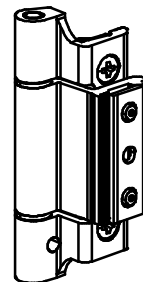

LÍMITE DE EMPLEO ACONSEJADO

Apertura Practicable (medidas por hoja):

Alto máximo recomendado: 2.400 mm

Ancho máximo Recomendado: 1.500 mm

Las medidas máximas pueden ser limitadas por el peso del vidrio. Revisar gráfico de medidas según peso y dimensiones.

NÚMERO DE PERNIOS SEGÚN DIMENSIONES

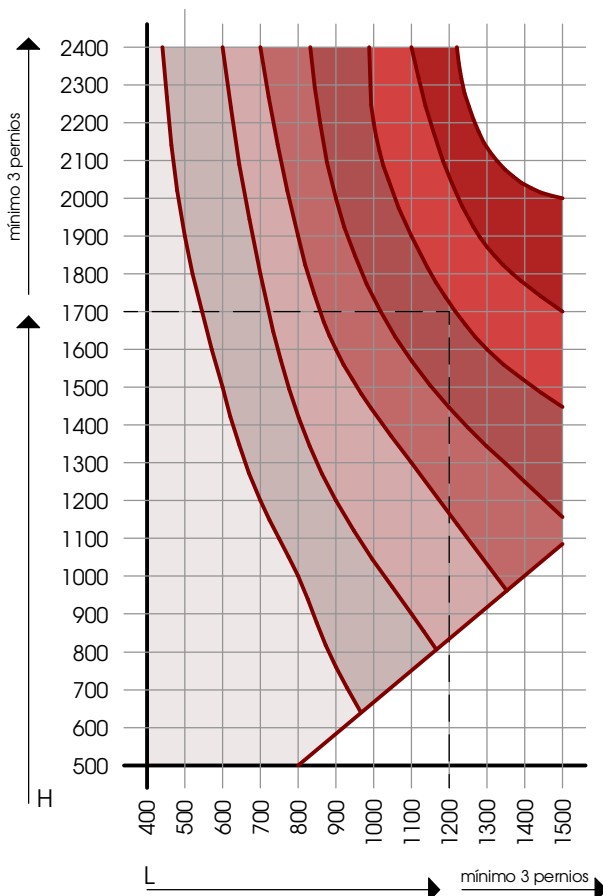

NÚMERO DE PERNIOS SEGÚN PESO

Kg/m ²	nº pernios
20	3
30	3
30	2
40	3
40	2
50	3
50	2
60	3
60	2
70	3
70	2
80	3

Nota:

Los pesos soportados en la tabla son Kg por metro cuadrado. El peso de cada línea es el máximo soportado.

Es posible que la tabla mande 2 pernios por peso, pero el gráfico mande 3 pernios por tamaño. En este caso manda el de mayor necesidad.

Ver página anterior para la posición de las bisagras.

Dimensiones - Accesorio Oscilobatiente - Galicube

COMPÁS	MEDIDA DE HOJA			
	DIMENSIONES MÁXIMAS		DIMENSIONES MÍNIMAS	
	H max.	L max.	H min.	L min.
0194-R1 Compás Pequeño	2400	750	500	402
0194-R2 Compás Mediano	2600	1400	700	562
0194-R3 Compás grande	2600	1700	700	816

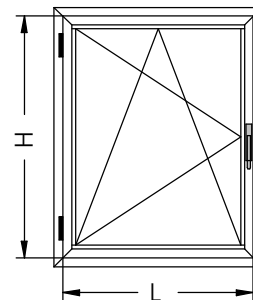

PESOS MÁXIMOS SOPORTADOS POR EL HERRAJE OSCILOBATIENTE

El peso máximo que soporta el herraje de la hoja oscilo-batiente es de 100Kg (para soportar 130Kg es necesario cambiar los pernos estandar. Ver tabla de la página anterior)..

Tabla con los espesores máximos de cristal que podemos usar en función del tamaño de ventana:

ALTO (H)	2400	40	37	33	31	26	23	20	18	17	15	14	13	12	11	11
	2300	40	38	34	32	27	24	21	19	17	16	15	14	13	12	11
	2200	40	40	36	33	29	25	22	20	18	17	15	14	13	13	12
	2100	40	40	37	35	30	26	23	21	19	17	16	15	14	13	12
	2000	40	40	39	37	31	28	24	22	20	18	17	16	15	14	13
	1900	40	40	40	39	33	29	26	23	21	19	18	17	15	14	14
	1800	40	40	40	40	35	31	27	24	22	20	19	17	16	15	14
	1700	40	40	40	40	37	32	29	26	24	22	20	18	17	16	15
	1600	40	40	40	40	39	34	31	28	25	23	21	20	18	17	16
	1500	40	40	40	40	40	37	33	29	27	24	23	21	20	18	17
	1400	40	40	40	40	40	39	35	31	29	26	24	22	21	20	18
	1300	40	40	40	40	40	40	38	34	31	28	26	24	23	21	20
	1200	40	40	40	40	40	40	40	37	33	31	28	26	24	23	22
	1100	40	40	40	40	40	40	40	40	36	33	31	29	27	25	24
	1000	40	40	40	40	40	40	40	40	40	37	34	31	29	28	26
	900	40	40	40	40	40	40	40	40	40	40	38	35	33	31	29
	800	40	40	40	40	40	40	40	40	40	40	40	39	37	X	X
	700	40	40	40	40	40	40	40	40	40	40	40	X	X	X	X
	600	40	40	40	40	40	40	40	40	40	X	X	X	X	X	X
	500	40	40	40	40	40	40	40	X	X	X	X	X	X	X	X
450	40	40	40	40	40	40	X	X	X	X	X	X	X	X	X	
	402	500	562	600	700	800	900	1000	1100	1200	1300	1400	1500	1600	1700	
	ANCHO (L)															

Notas:

Los datos obtenidos son los espesores máximos de cristal para cada medida de hoja (en el espesor de cristal no hay que incluir la cámara del vidrio).

En las casillas de sombreadas se indica el espesor máximo de cristal que se puede instalar para no sobrepasar el peso de 110 Kg.

Las casillas marcadas con "X" no se pueden realizar.

En las casillas de sombreado blanco no existe problema, ya que soporta más espesor del que se puede acristalar (se ha limitado el valor a 40mm).

Accesorio Oscilobatiente - Galicube - Referencias

					 KG	 ACABADO
KIT 1H Completo	0194-A	●		402÷750	110	LB
						LC
KIT 1H Completo	0194-B	●		562÷1200	110	LB
						LC
KIT 2H Completo	0194-E		●	402÷750	110	LB
						LC
KIT 2H Completo	0194-F		●	562÷1200	110	LB
						LC
Bisagras Hoja Activa Pareja	0194-I	●	●		110	LB
						LC
Bisagras Hoja Pasiva Pareja	0194-J		●		130	LB
						LC
Compás Corto Medio Largo	0194-R1	●	●	402÷750	130	SA
	0194-R2	●	●	562÷1200	130	SA
	0194-R3	●	●	816÷1700	130	SA
KIT 1H Base	0194-K1	●				SA
KIT 2H Base	0194-K2		●			SA

Accesorio Oscilobatiente - 1H y 2H

0194-A

0194-B



REF.	DESCRIPCIÓN	 Kg
0194-A	Kit Completo 1 Hoja Compás Corto	110
0194-B	Kit Completo 1 Hoja Compás Medio	110

Notas:
Cremona y enganche cremona de Fapim.

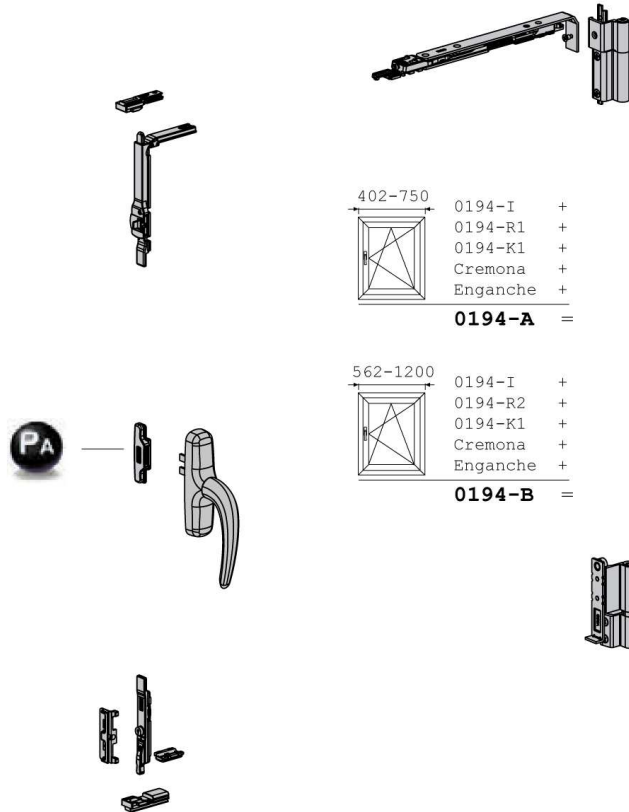

402-750
 0194-I +
 0194-R1 +
 0194-K1 +
 Cremona +
 Enganche +
0194-A =

562-1200
 0194-I +
 0194-R2 +
 0194-K1 +
 Cremona +
 Enganche +
0194-B =

0194-E

0194-F



REF.	DESCRIPCIÓN	 Kg
0194-A	Kit Completo 2 Hojas Compás Corto	110
0194-B	Kit Completo 2 Hojas Compás Medio	110

Notas:
Cremona y enganche cremona de Fapim.

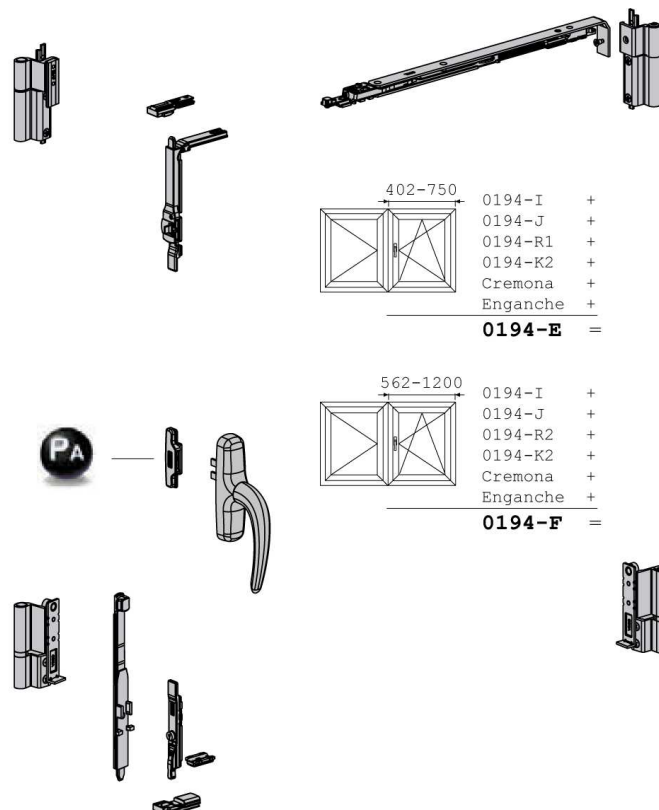

402-750
 0194-I +
 0194-J +
 0194-R1 +
 0194-K2 +
 Cremona +
 Enganche +
0194-E =

562-1200
 0194-I +
 0194-J +
 0194-R2 +
 0194-K2 +
 Cremona +
 Enganche +
0194-F =

Accesorio Oscilobatiente - 0194I

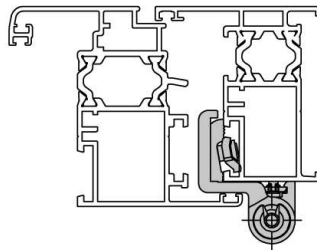
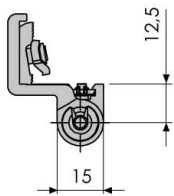
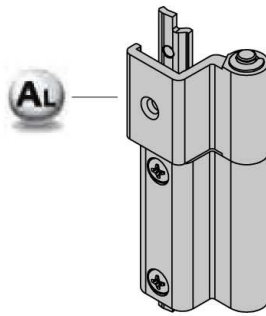
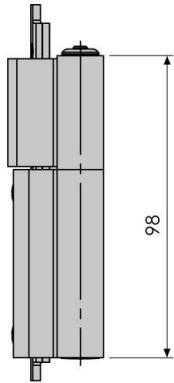

REF.	DESCRIPCIÓN	Kg
0194-I	Pernios hoja Activa (pareja)	110

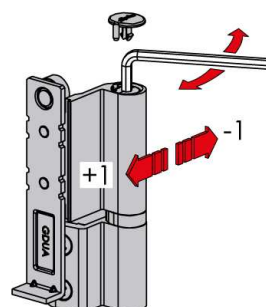
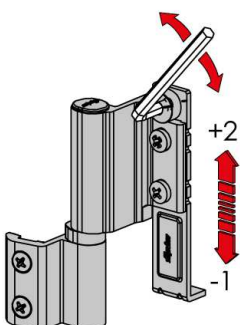
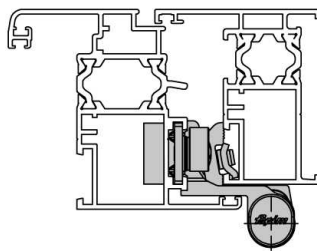
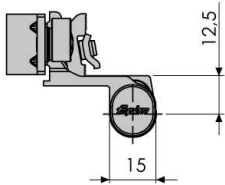
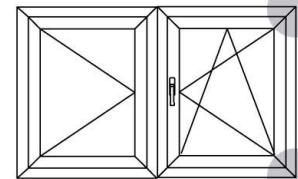
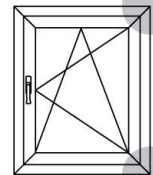
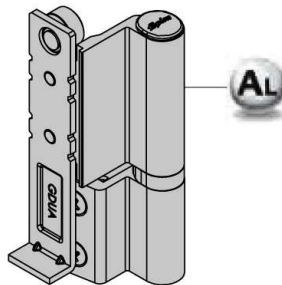
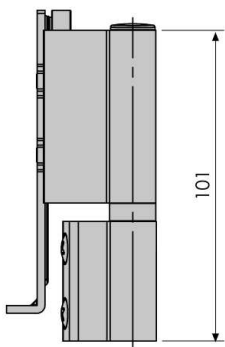

Accesorio Oscilobatiente - 0194J



REF.	DESCRIPCIÓN	Kg
0194-J	Pernios Hoja Pasiva (pareja)	130

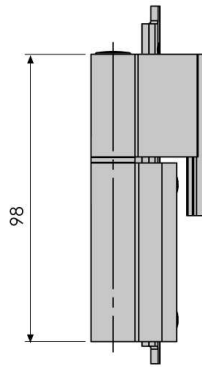

AL

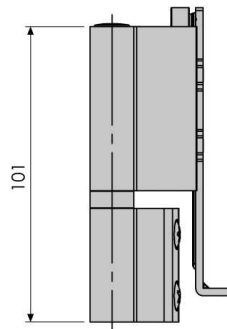
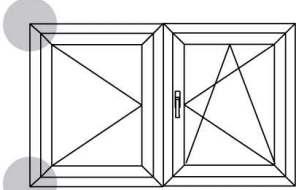
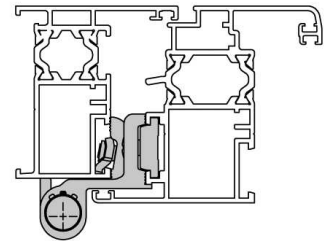
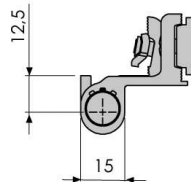
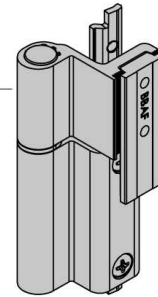

AL

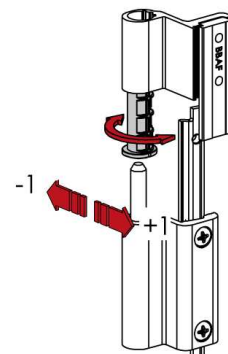
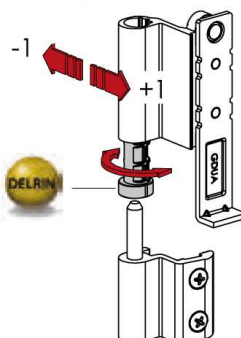
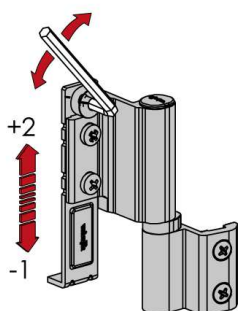
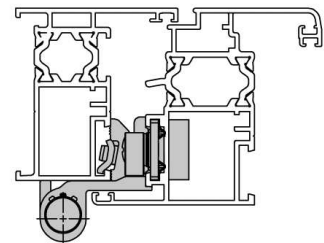
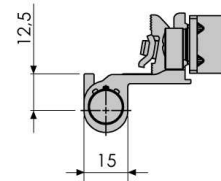
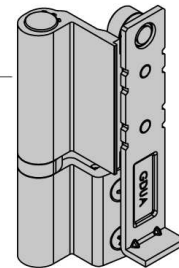

Accesorio Oscilobatiente - 0194K1

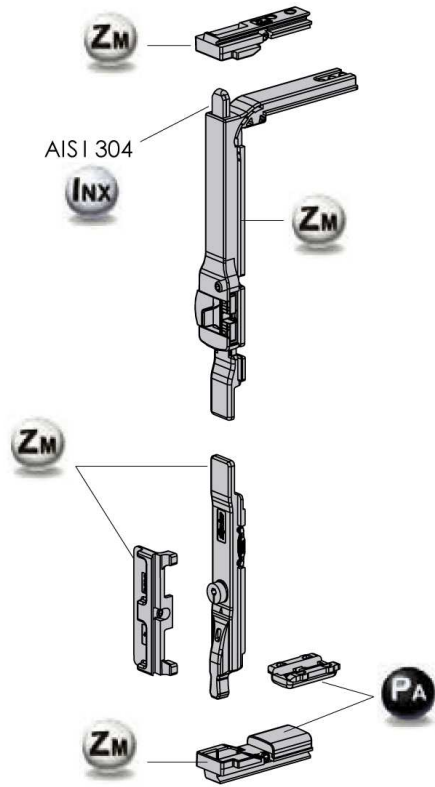

REF.	DESCRIPCIÓN
0194-K1	Kit 1 Hoja (base)

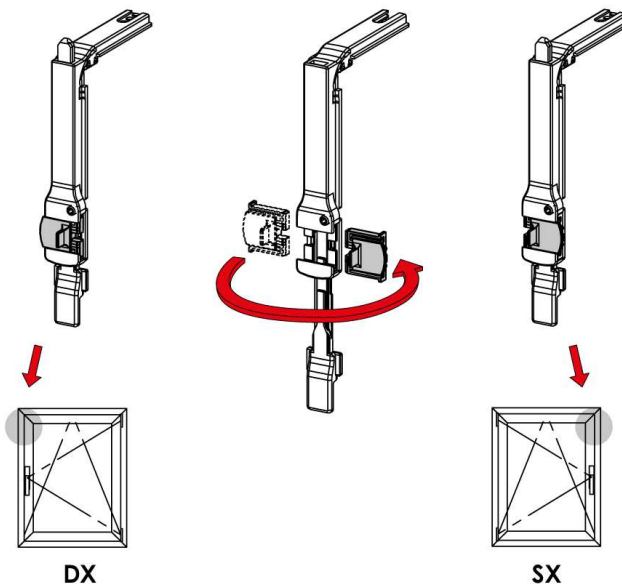
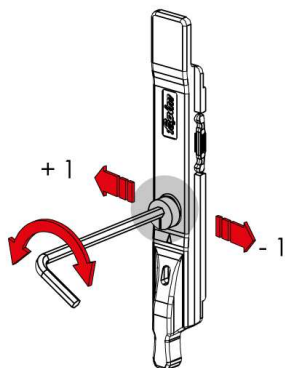
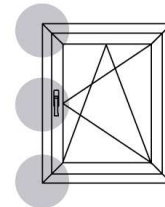

Accesorio Oscilobatiente - 0194K2



REF.	DESCRIPCIÓN
0194-K2	Kit 2 Hojas (base)

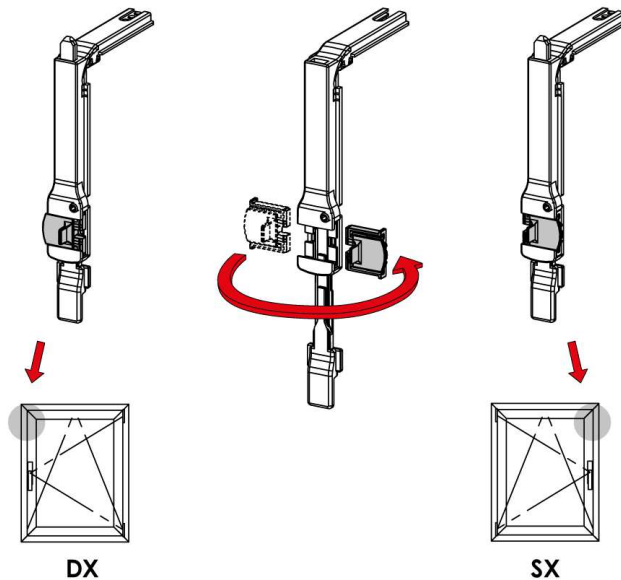
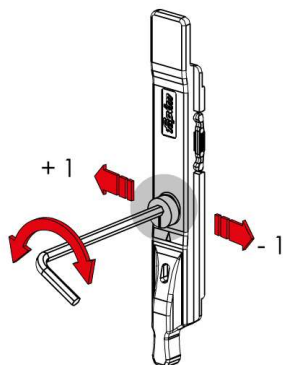
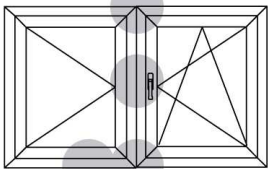
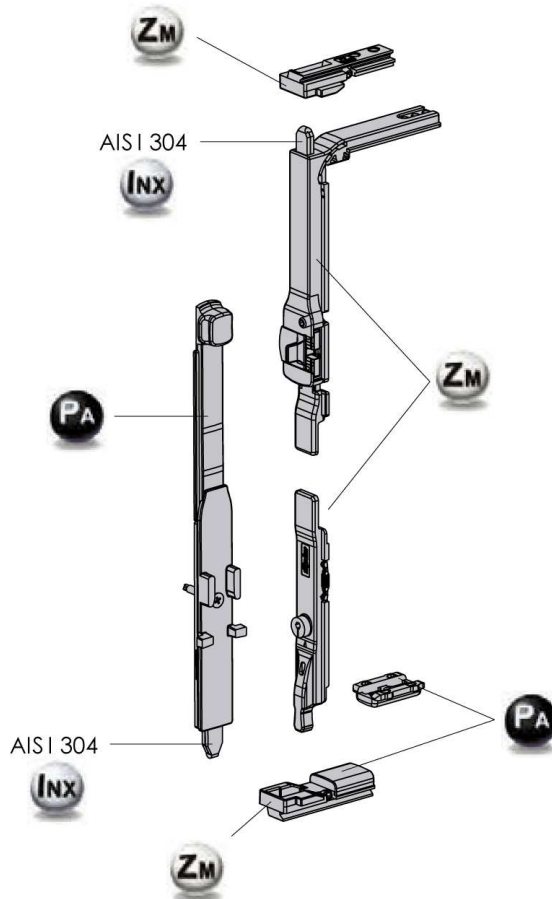

Accesorio Oscilobatiente - 0194R



REF.	DESCRIPCIÓN	L	Kg
0194-R1	Compás Corto	402÷750	110 130
0194-R2	Compás Medio	562÷1200	
0194-R3	Compás Largo	816÷1700	

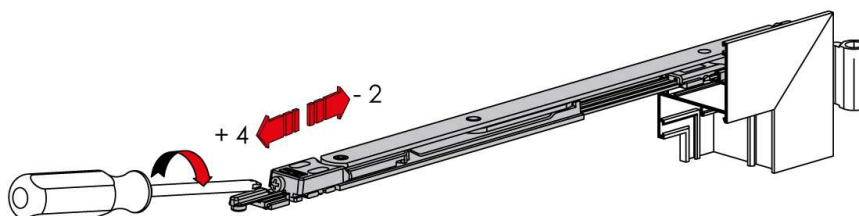
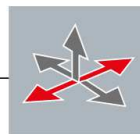
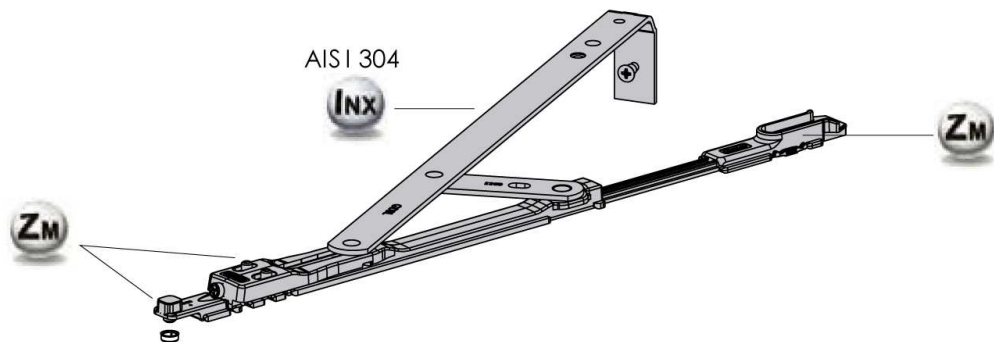
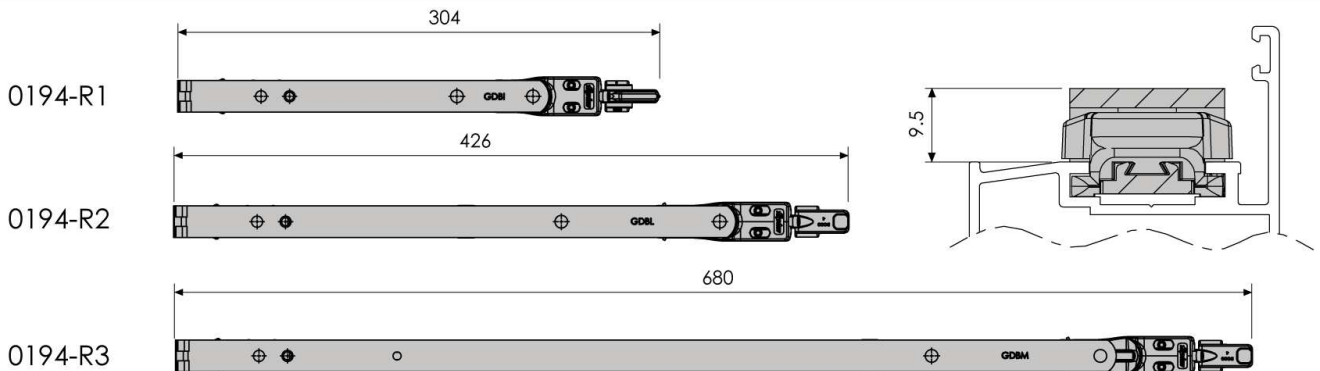
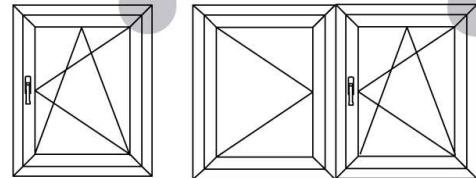

Accesorio Oscilobatiente - Regulaciones

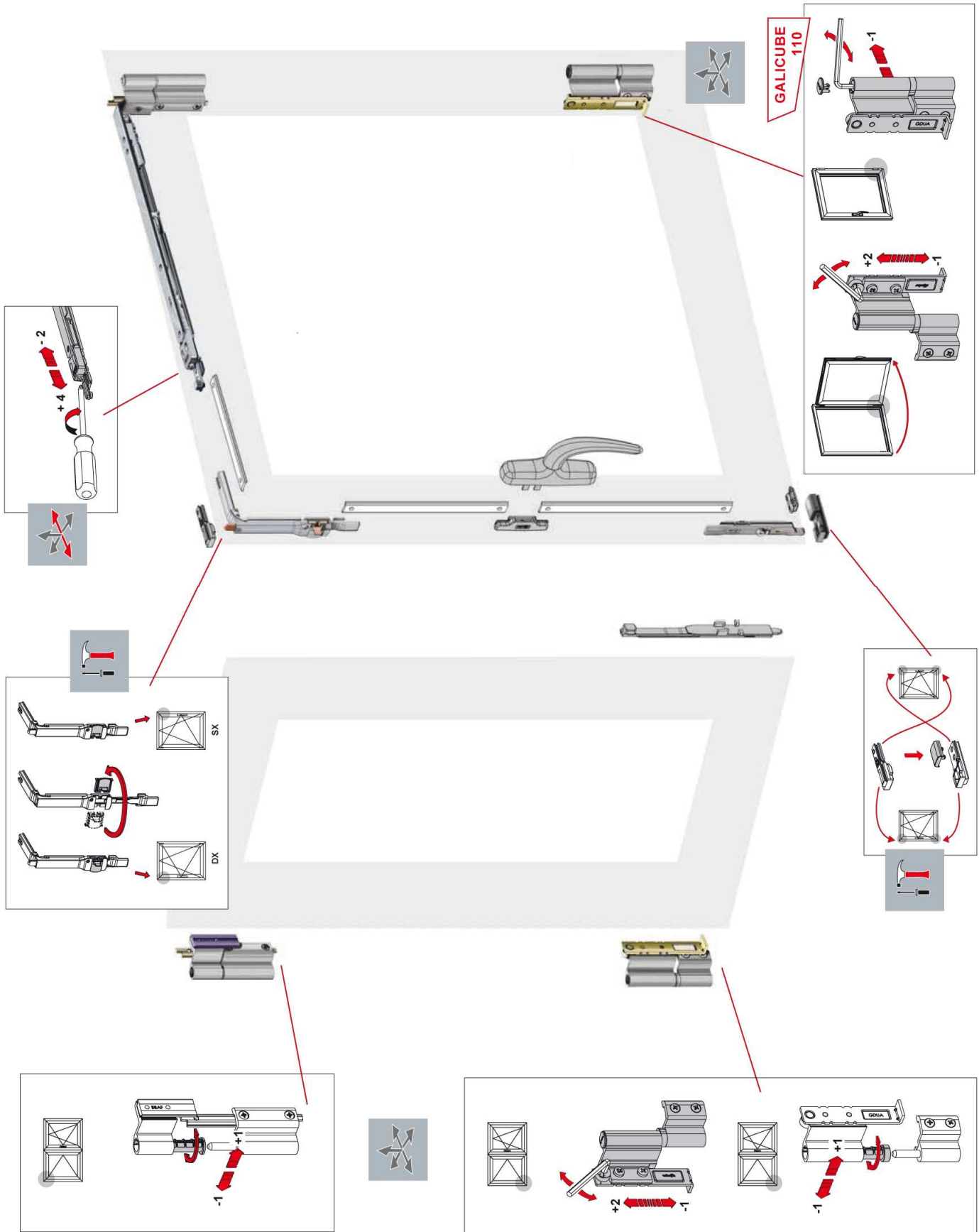

Herraje Apertura Exterior - Herraje Superpuesto

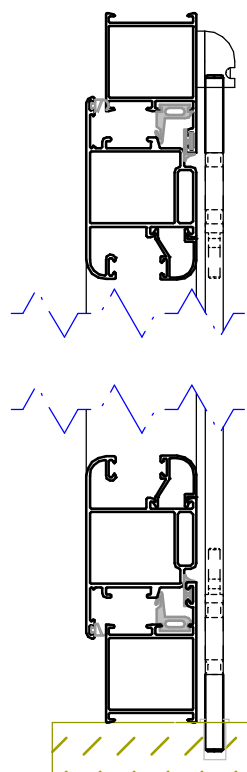
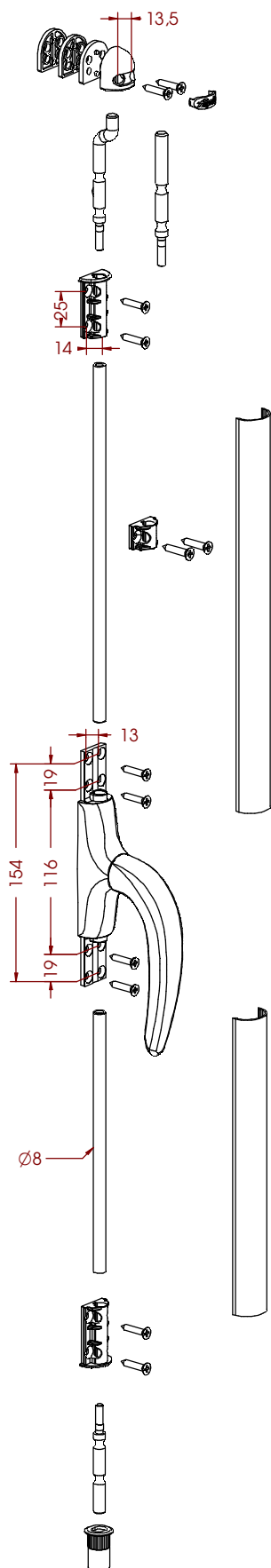

Ejemplo

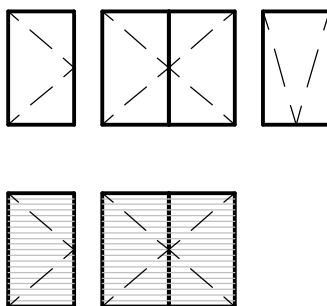

Nota: Válido para todas las series practicable.

<p>Ref. 1870</p>
<p>Ref. 0245 - 1800mm Ref. 0246 - 1000mm Ref. 0247 - 1400mm</p>
<p>Ref. 0258</p>
<p>Ref. 0259</p>
<p>Ref. 0242</p>
<p>Ref. 0244</p>
<p>Ref. 0243</p>

Herraje Apertura Exterior - Pletina 1608

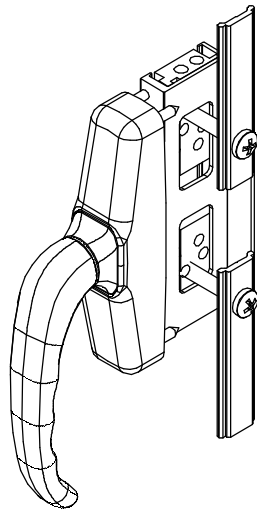
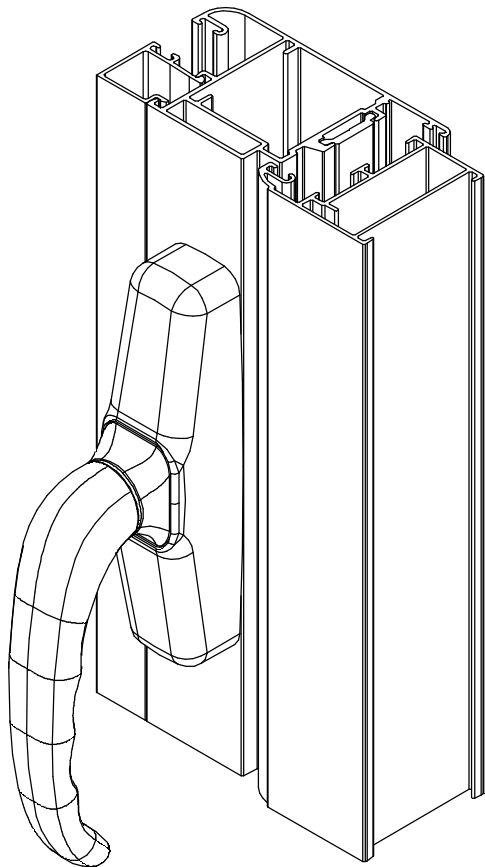

Terminales y Cierres
 Ref. 0630

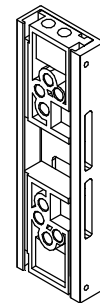

Ref. 0007 - Enganche
 1:3

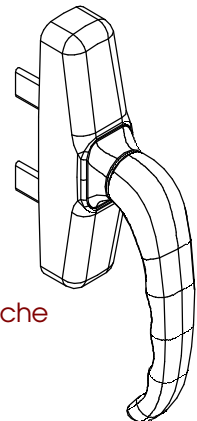

Cremona Ap. Exterior - Ref. 0006
 1:3

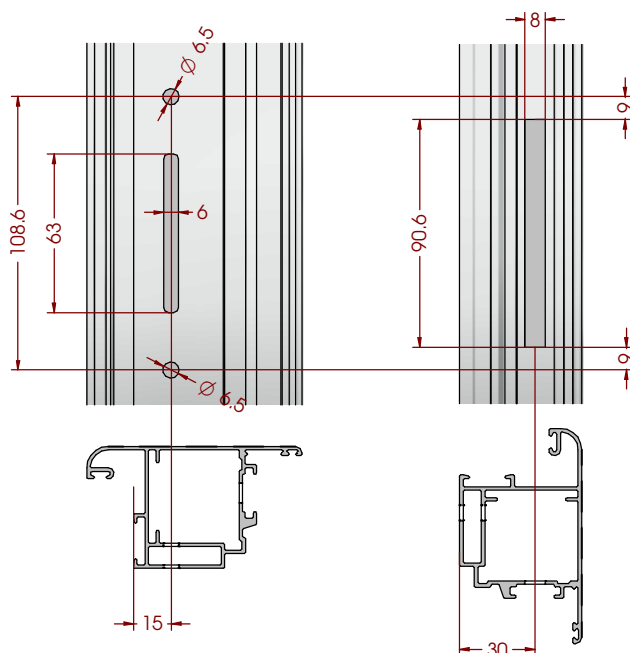
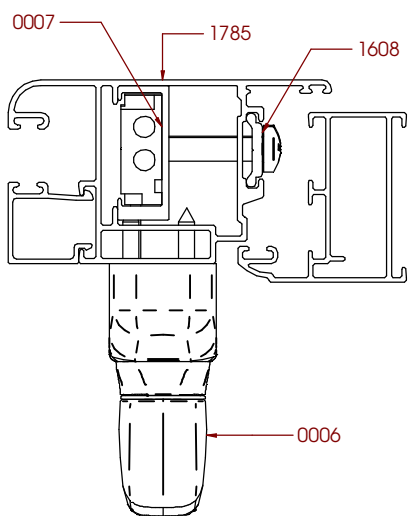

Pernio Pivotante

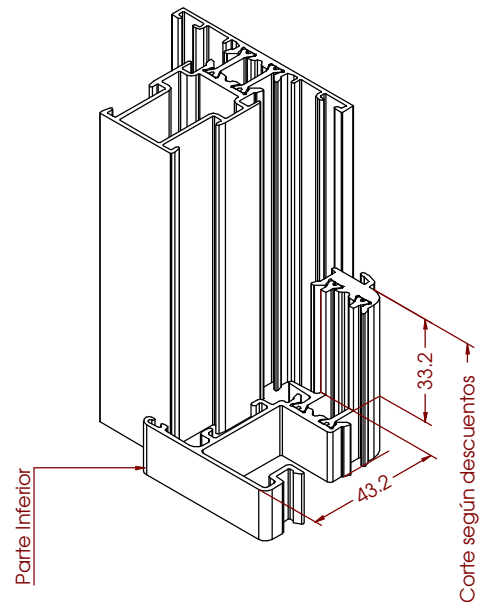
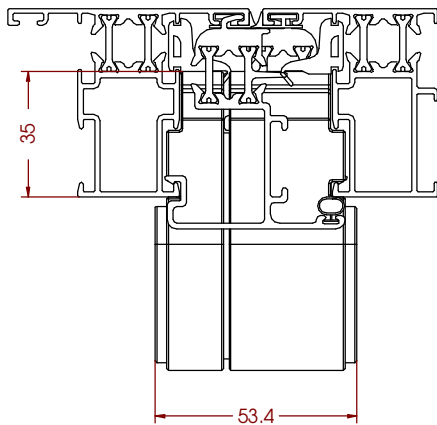
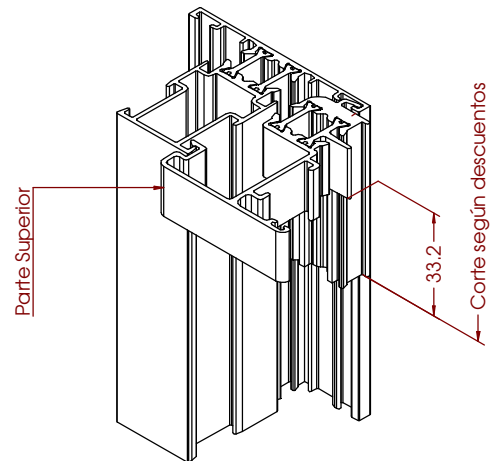
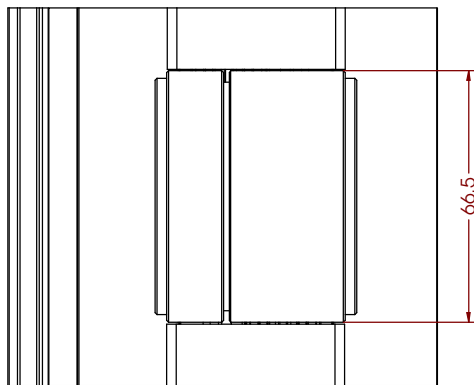
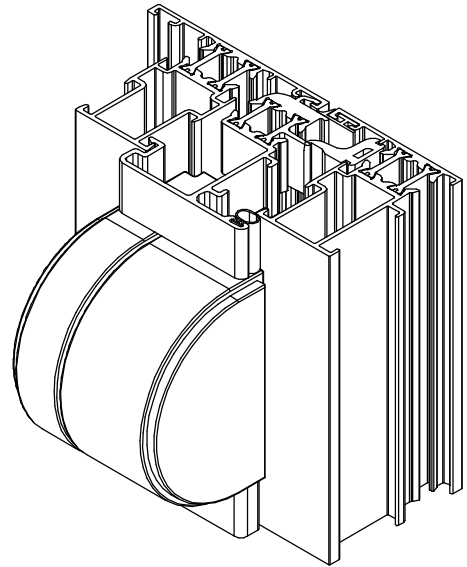
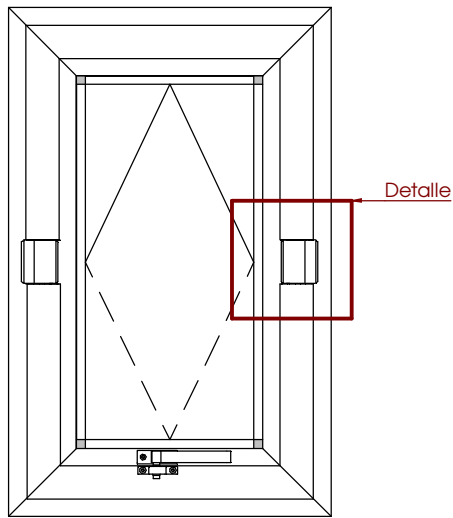

Destajar un mínimo de 35mm de profundidad y 33,2mm de altura.



QR-Code
Usa tu smartphone para
ver el catálogo online.

GRUPO AYUSO
Avda. de la industria, 8-10
28822 - Coslada (Madrid)
www.grupoayuso.org

